

RELECO TIDSSTYRING TIL 11-STIFTS RELÆER

CT3E30L

Tidsblok 11P 20-65V UC on delay

- Giver 3 skiftekontakter
- Multiindgangsspænding, V AC/DC
- Multitidsrum 0,2 sek - 30 min.



PRODUKTBESKRIVELSE

SPECIFIKATIONER

Nominel spænding	20-65 V AC/DC
Egetforbrug	6 mA
Indkoblingstid	AC-80 ms / DC-50 ms
Lækstrøm	≤ 0.3 mA
IP-klasse	IP40
Materiale	Lexan
Temperaturområde fra	-25 °C
Temperaturområde lager fra	-40 °C
Temperaturområde lager til	70 °C
Temperaturområde til	60 °C
Type	On delay
Vægt	35 g
Gendannelsestid	200 ms
Godkendelser	CE, CSA, RoHS, UL
Tidsinterval	0,2 s - 30 min

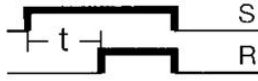
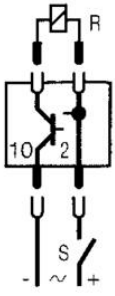

Range
 0,2 - 3 s
 2 - 30 s
 0,2 - 3 min
 2 - 30 min

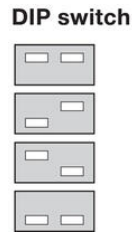

Time
 Adjusting knob
 1 ... 10

Relä



Tidkub

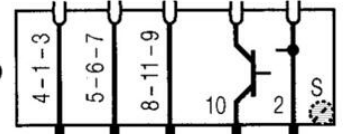

Socket

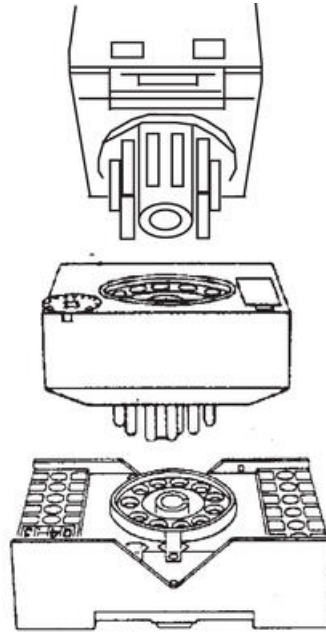
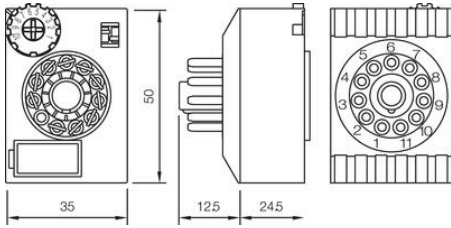

Range
 0,2 - 3 s
 2 - 30 s
 0,2 - 3 min
 2 - 30 min



Time
 Adjusting knob
 1 ... 10

Relä



Tidkub

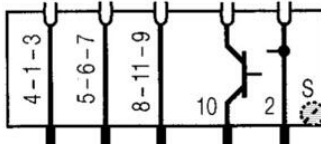

Socket

