

UAM-05 - SIKKERHEDSLASERSCANNER STANDARD

Sikkerhedslaserscanner

UAM-05LP-T301

Sikkerheds scanner 270° 5m, 3m kabel

- Verdens mindste laserscanner
- 5m sikkerhedszone
- 20m advarselszoner
- 4 OSSD sikkerhedsudgange
- Type 3, SIL 2, PLd



PRODUKTBESKRIVELSE

UAM-05, er med sine fysiske mål på 80x80x95mm, den mindste sikkerheds laser scanner på markedet, men dette har ikke sat begrænsninger for de mange features.

Via det simple konfigurerings software, kan selv ret komplicerede advarsels og beskyttelses zoner let indstilles manuelt eller via teach in. Zonerne kan også overvåges kontinuerligt, således at en eventuel efterjustering hurtigt rettes til.

Under drift overvåges det programmerede område af laserenheden, som aflæser afstanden til objektet ved princippet Time off flight (TOF). En pulserende laser stråle udsendes i en 270° roterende bevægelse, og hvis denne stråle reflekteres af et objekt inden for sikkerheds zonen, brydes OSSD udgangene. Sker det i en advarsels zone, vil det ikke afbryde OSSD udgangene, men man kan istedet få alarm signaler der kan bruges på anden vis.

Skannings område

Skanningsområdet kan indeholde både sikkerheds zoner og advarsels zoner som yderligere kan programmeres på 2 forskellige måder. UAM-05 dækker et område på max. 5 meter sikkerheds zone og 20 meter advarsels zone, med 270° skannings vinkel

Metode 1 - som 2 særskilte sikkerheds zoner, der hver har 2 OSSD udgange. Her er der ingen advarsels zoner.

Metode 2- som 1 sikkerheds zone og 2 advarsels zoner.

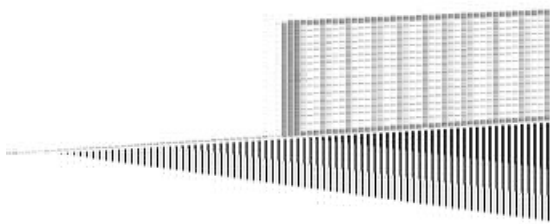

Protection zone 1

Protection zone 2

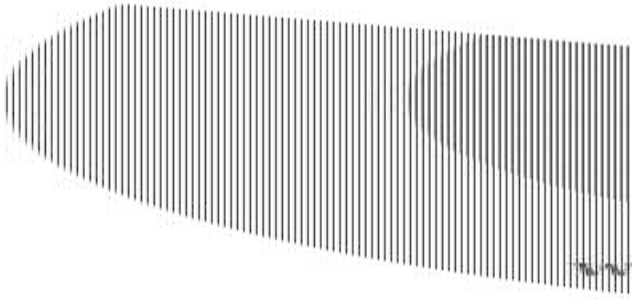

Anvendelses områder

<p>Område overvågning (fast)</p>	<p>Område overvågning (mobilt)</p>	<p>Område overvågning (som gitter)</p>

Data output

Måledata kan udløses via Ethernet, sammen med ind- og output tilstanden. Understøtter SCIP2.0 protokol

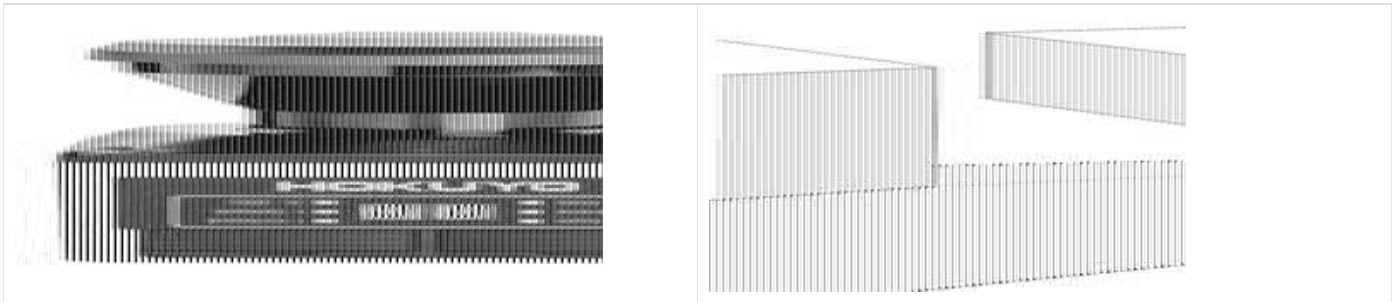

Konfiguration

UAM kan enten programmeres via et forudprogrameret SD kort, eller med en PC, der er tilsluttet via USB.

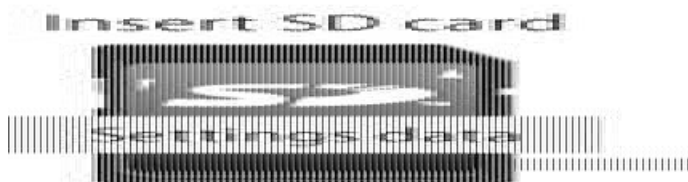

Master/Slave-funktion

Hvis et større område skal overvåges, kan op til 4 enheder kombineres direkte i en master / slave opsætning.

Warning Zone 2 —
Warning Zone 1 —
Protection Zone —

Encoder indgang

Hvis UAM-05 anvendes på AGV(Automatic guided vehicle) applikation, kan man med fordel anvende encoder indgangen, således at zonerne kan ændres i overensstemmelse med hastigheden.

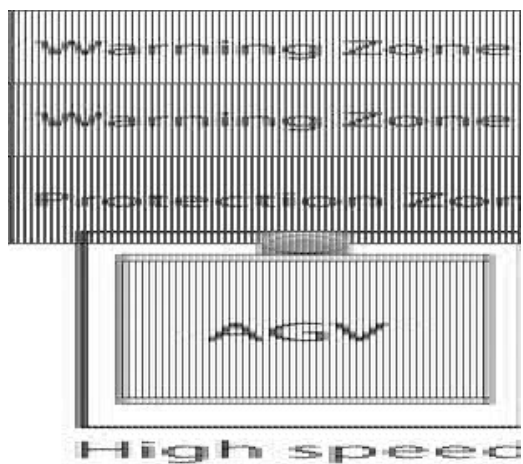

SPECIFIKATIONER

Advarselsfelt max	20 m
Antal sikkerhedsfelter	128 pc
Bredde	80 mm
Forsyningsspænding	24 V DC
Godkendelser	BG, CE, cULus, TÜV
Højde	95 mm
I henhold til	EMC, LVD, MD
IP-klasse	IP65
Længde	80 mm
Laserklasse	Class 1
Materiale frontglas	Polykarbonat
Materiale hus	Aluminium
Scanningsvinkel	270 °
Sikkerhedsfelt max	5 m
Spændingstolerance	±10 %
Temperaturområde fra	-10 °C

Temperaturområde til	55 °C
Tolerance	+100 mm
Udkoblingstid max	510 ms
Udkoblingstid min.	60 ms
Vægt	0,8 kg

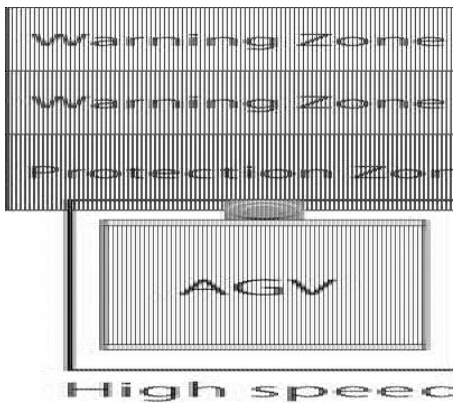
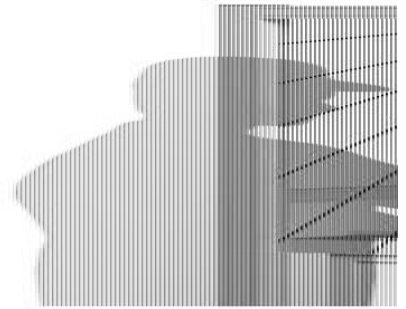
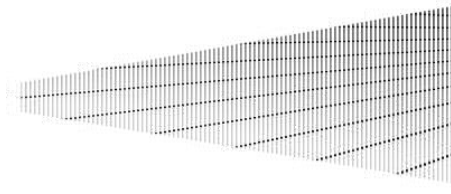
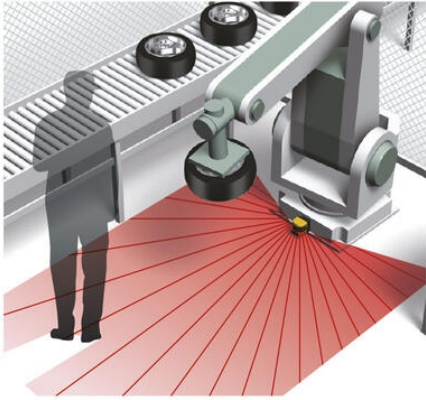

Warning Zone 2 —
 Warning Zone 1 —
 Protection Zone —

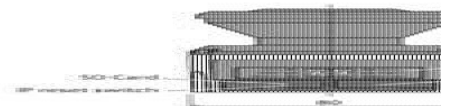
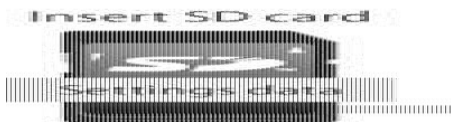
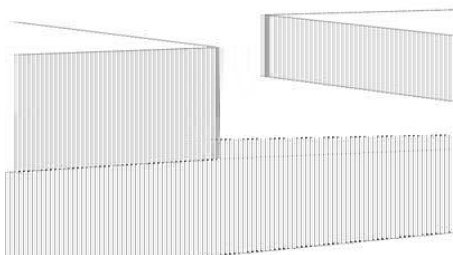
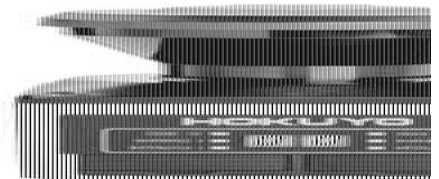

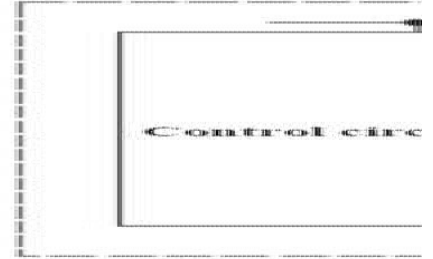
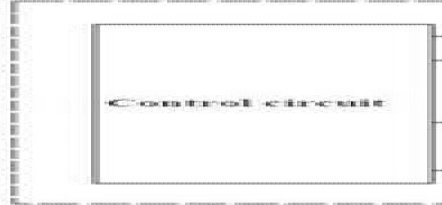
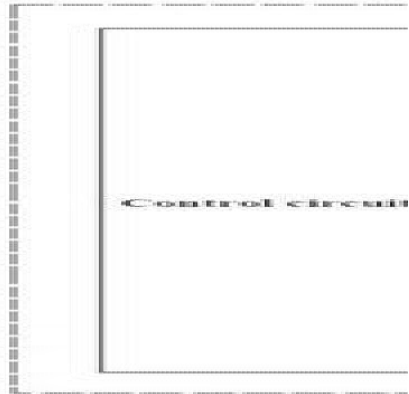
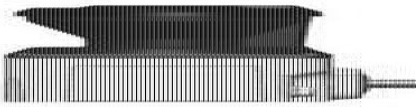

- OSSD 1/2 indicator
- Warning 1 indicator
- Interlock 1 indicator

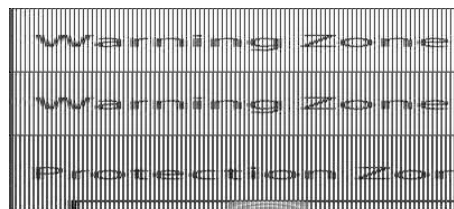
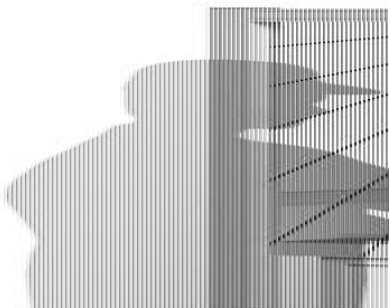
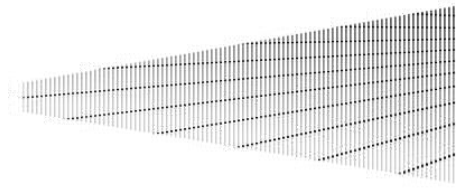
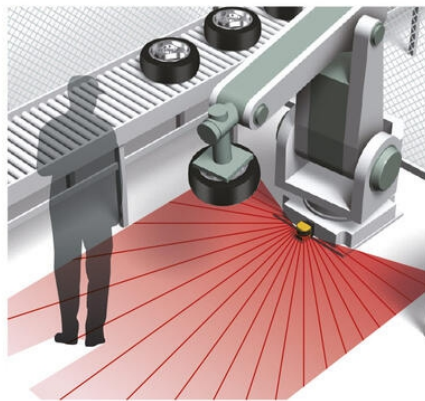

- Warning Zone 2 —
- Warning Zone 1 —
- Protection Zone —

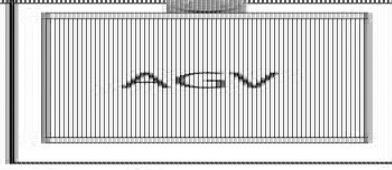

High speed

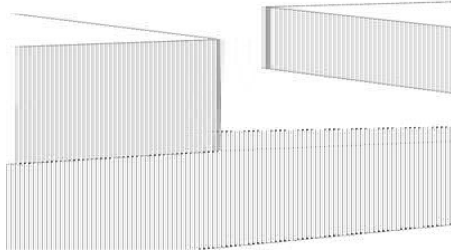
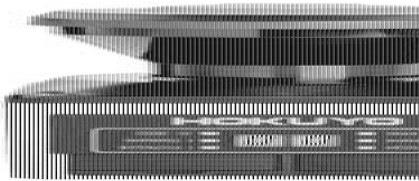

Insert SD card

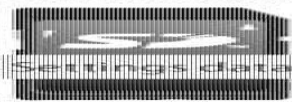

SD-Card
Insert position

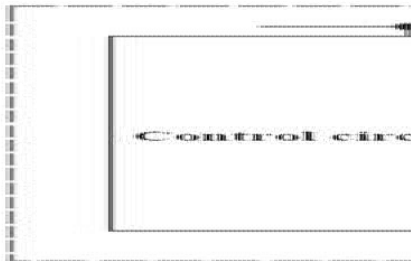
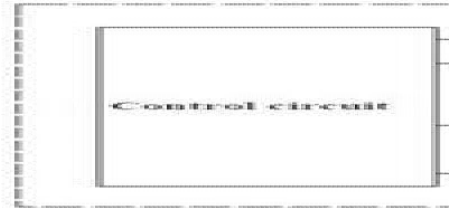
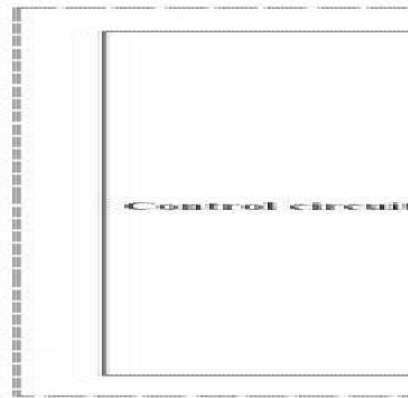
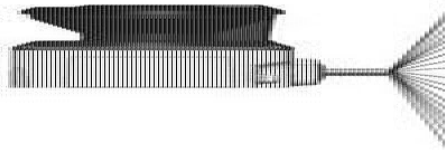
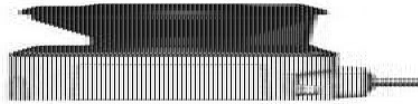
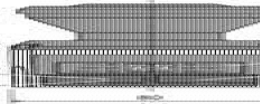

- OSSD 1/2 indicator
- Warning 1 indicator
- Interlock 1 indicator